



**GAS COMPONENTS**



**ELECTRIC COMPONENTS**



**WATER TECHNOLOGY**



**MECHANICAL COMPONENTS**



**TOOLS**

Spare parts suitable for

**BIANCHI VENDING**

Find the complete and up-to-date range of products in our GEV Webshop



# Manufacturer catalogue

The most important spare parts and accessories arranged clearly for every manufacturer

- ✓ Complete product range and all appliance data always up to date in the GEV Webshop
- ✓ Alphabetical Index at the end of the catalogue

## GEV Webshop

[www.gev-online.co.uk](http://www.gev-online.co.uk)

[www.gev-online.com](http://www.gev-online.com)







- 🔍 Add to Favourites
- 🔍 Sign In with email address and usual password
- 🔍 Easy-order – place several items in your basket at the same time
- 🔍 Quick Item search – no login needed



## heating elements

### heating elements for coffee machine

			
1			
<b>GEV No.</b>	417048	<b>Ref. No.</b>	29006911
<b>description</b>	heating element 2400W 230V heating circuits 2 thread 1¼" L 235mm W 34mm H 24mm tube ø 8.4mm connection male faston 6.3mm immersion heater connection length 31mm flange with thread WS 37		
<b>accessories for</b>	417048		
	<b>GEV No.</b>	510405	<b>Ref. No.</b> —
	 flat gasket fibre ED ø 56mm ID ø 42mm thickness 2mm for thread 1¼" Qty 1 pcs		
	<b>GEV No.</b>	528021	<b>Ref. No.</b> —
	 flat gasket PTFE ED ø 53mm ID ø 42.5mm thickness 3mm Qty 1 pcs equiv. no. 12001/02286 suitable for Astoria/Aurora/Brasilia/Wega		

			
1			
<b>GEV No.</b>	420490	<b>Ref. No.</b>	29007011
<b>description</b>	heating element 3000W 230V heating circuits 2 mounting ø 49mm hole distance 57.5mm L 340mm W 27mm H 50mm L1 35mm L2 55mm L3 235mm hole ø 10.5mm tube ø 8mm		

## switches and momentary switches

### push/momentary push switches

#### 20.6x16.4mm

			
1			
<b>GEV No.</b>	348141	<b>Ref. No.</b>	0003170601 43052810
<b>description</b>	push switch mounting measurements 20.6x16.4mm black/chrome 2NO 250V 16A connection male faston 6.3mm ambient temperature max. 85°C protection IP40		

#### ø25mm

			
1			
<b>GEV No.</b>	348142	<b>Ref. No.</b>	26053416
<b>description</b>	momentary switch mounting ø 25mm red 1NO/indicator light 250V 16A connection male faston 6.3mm ambient temperature max. 85°C protection IP40		

## microswitches

### lever actuated

			
1			
<b>GEV No.</b>	348180	<b>Ref. No.</b>	41022916 8841022916
<b>description</b>	microswitch 250V 16A 1CO connection F6.3 L 27mm mounting distance 22mm		

			
1			
<b>GEV No.</b>	381416	<b>Ref. No.</b>	8826004346
<b>description</b>	microswitch 250V 5A 1CO connection F6.3 L 40mm mounting distance 22mm actuating force: 250g		

## float switches

			
1			
<b>GEV No.</b>	348160	<b>Ref. No.</b>	93012020-01 93012020-02
<b>description</b>	float switch 2CO ø 6/13mm L 115mmV 6mm		



## relays



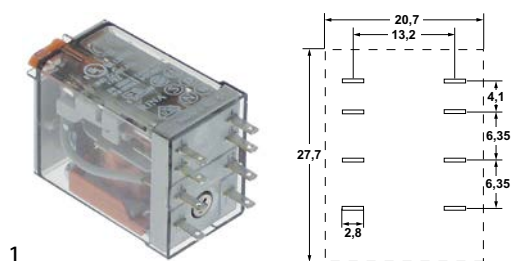

## power relays

with male contacts

female contact 2.0mm



1

<b>GEV No.</b>	381415	<b>Ref. No.</b>	26017316 8826017316
<b>description</b>	power relays 24VAC 10A 2CO connection F2 plug-in connection manuf. no. 55.32.8.024.0040 94.92.3 250V connection 2mm		
<b>accessories for</b>	381415		
	<b>GEV No.</b>	380341	<b>Ref. No.</b> —
	relay socket 4-pole contacts 12 300V voltage AC 6A Italiana Relè manuf. no. ZMD4		
	<b>GEV No.</b>	380378	<b>Ref. No.</b> —
	relay socket 2-pole 55/85 dimensions 70.5x30x27mm 250V voltage AC 10A FINDER manuf. no. 94.72		
	<b>GEV No.</b>	380384	<b>Ref. No.</b> —
	relay socket 2-pole contacts male faston 2.8mm 250V voltage AC 10A W 23mm for		
	<b>GEV No.</b>	380399	<b>Ref. No.</b> —
	relay socket 4-pole dimensions 76.2x27x86.1mm 250V voltage AC 1A FINDER manuf. no. 94.94.3		

## level relays

GICAR



1

<b>GEV No.</b>	402103	<b>Ref. No.</b>	26053616
<b>description</b>	level controller 230/240V voltage AC 50/60Hz connection F6.3 type NRL30/1E-2C/F		

## electronics

## central units



1

<b>GEV No.</b>	402939	<b>Ref. No.</b>	26053716
<b>description</b>	central unit 2-group 230V 50/60Hz type 3d5 Maestro 2GRCD voltage AC		



1

<b>GEV No.</b>	403083	<b>Ref. No.</b>	26053916
<b>description</b>	control box 230V 50/60Hz type 3d5 3GRC XLC (SC)		

## keypads

## membrane keypads



1

<b>GEV No.</b>	403152	<b>Ref. No.</b>	000475.06.08 30265811 30265811-01
<b>description</b>	membrane keypad espresso machine buttons 5 L 125mm W 45mm		



## solenoid valves

### solenoid valves (water)

metal

OLAB

solenoid valves

3-way



1

<b>GEV No.</b>	370822	<b>Ref. No.</b>	25018016 8825018016
<b>description</b>	solenoid valve brass 3-ways 24VAC inlet 1/8" ET outlet 1/8" IT connection 1/8" L 50mm DNmm slide-on receptacle DIN Olab coil type 8000 membranes NBR p maxbar p minbar		

PARKER

3-way



VE-128 series





1

<b>GEV No.</b>	370057	<b>Ref. No.</b>	000322.06.01
<b>description</b>	solenoid valve 3-ways 230VAC body outer cone DN 1.2mm slide-on receptacle DIN -20° up to 140°C PARKER type series VE-128 coil type ZB09 membranes ruby p max 10bar brass flange 32x32mm		

**spare parts for** 370057

	<b>GEV No.</b>	370062	<b>Ref. No.</b>	—
solenoid valve body PARKER 3-ways outer cone				
	<b>GEV No.</b>	371029	<b>Ref. No.</b>	—
solenoid coil PARKER 230VAC 9VA coil type ZB09 seat ø 14mm H 33mm W 34mm D 43mm				

**accessories for** 370057

	<b>GEV No.</b>	371090	<b>Ref. No.</b>	—
power socket plug type DIN 43650A screw				
	<b>GEV No.</b>	371095	<b>Ref. No.</b>	—
O-ring Viton thickness 1.78mm ID ø 6.07mm Qty 1 pcs				
	<b>GEV No.</b>	371100	<b>Ref. No.</b>	—
O-ring silicone thickness 1.78mm ID ø 6.07mm Qty 1 pcs				



1

<b>GEV No.</b>	370693	<b>Ref. No.</b>	25034416
<b>description</b>	solenoid valve 3-ways 230VAC body outer cone slide-on receptacle DIN -20° up to 140°C PARKER type series VE 128R coil type ZB09 membranes ruby p max 20bar 230V brass voltage AC flange 32x32mm		

## pressure switches

### for coffee machines

miscellaneous



1

<b>GEV No.</b>	541453	<b>Ref. No.</b>	25034516
<b>description</b>	pressure control pressure range adjustable 0.5-1.4bar connection 1/4" 25A 3-pole type PS325 pressure connection vertical 250V coffee machine parts PARKER		

## electrodes



1

<b>GEV No.</b>	400214	<b>Ref. No.</b>	26053126
<b>description</b>	level electrode 1/4" total length 140mm probe L 112mm insulated probe length 26mm connection male faston 6.3mm stainless steel ø 2.5mm		

## flow meters and flow sensors

### flow meters

DIGMESA



1

<b>GEV No.</b>	403663	<b>Ref. No.</b>	24021916
<b>description</b>	flow meter thread 1/4" brass approval NSF reducer ø 1.2mm		



## VENDING



1

<b>GEV No.</b>	400565	<b>Ref. No.</b>	24011216 8824011216
<b>description</b>	flow meter hose ø 6mm plastic plug-in connection approval NSF DIGMESA		

## fans

## cross flow fans

## COPREL

with standard coil



1

<b>GEV No.</b>	602060	<b>Ref. No.</b>	20015916
<b>description</b>	cross flow fan COPREL FFR roller ø 60mm roller length 240mm laminated core thickness 20mm motor position right 230V/50-60Hz 33W universal bearing silicone connection male faston 6.3mm airflow 149m <sup>3</sup> /h -10 up to +60°C		



1

<b>GEV No.</b>	602117	<b>Ref. No.</b>	20021016
<b>description</b>	cross flow fan COPREL FFR roller ø 60mm roller length 270mm laminated core thickness 20mm motor position right 230V/50-60Hz 30W universal bearing silicone connection male faston 6.3mm airflow 149m <sup>3</sup> /h -10 up to +60°C		

## pumps

## booster pumps II

## pump heads

## FLUID-O-TECH



1

<b>GEV No.</b>	500454	<b>Ref. No.</b>	27011516
<b>description</b>	pump head PA1504 FLUID-O-TECH L 82mm 150l/h connection 3/8" NPT with bypass brass clip connection for coffee machine shaft ø 4.8x11mm approval NSF		

## vibration pumps



1

<b>GEV No.</b>	501533	<b>Ref. No.</b>	27002816 8827002816
<b>description</b>	vibration pump type 1106DHDLME 230V 50Hz 70W inlet ø 8mm outlet ø 1/8" IT outlet conical L 129mm FLUID-O-TECH		

## equipment-specific units

## for espresso machines

## filter holders

## filter holders standard

## filter holders (complete)





1

<b>GEV No.</b>	531289	<b>Ref. No.</b>	12047711
<b>description</b>	filter holder single complete mounting ø 83mm ID ø 62mm wedge height 6mm number of wedges 2		





spouts			
with thread 3/8"			
			
1			
<b>GEV No.</b>	531163	<b>Ref. No.</b>	43051816
<b>description</b>	filter holder spout thread 3/8" 1-way curved/long outlet distance cups 1 thread L 11mm		

			
1			
<b>GEV No.</b>	531164	<b>Ref. No.</b>	43052116
<b>description</b>	filter holder spout thread 3/8" 2-way curved/long outlet distance 44mm cups 2 thread L 11mm		

filters			
for 1 cup			
			
1			
<b>GEV No.</b>	531290	<b>Ref. No.</b>	16022811
<b>description</b>	coffee filter ø 70mm mounting ø 60.8mm H 24.5mm cups 1		

for 2 cups			
			
1			
<b>GEV No.</b>	531291	<b>Ref. No.</b>	16022911
<b>description</b>	coffee filter ø 70mm mounting ø 60.8mm H 24.5mm cups 2		

filter holder springs			
			
1			
<b>GEV No.</b>	531243	<b>Ref. No.</b>	N/A
<b>description</b>	filter holder spring L 70mm W 60mm wire gauge ø 1.3mm for espresso filter holder Qty 20 pcs		

brewing units			
shower screens			
with upstand			
			
1			
<b>GEV No.</b>	525844	<b>Ref. No.</b>	16022711
<b>description</b>	shower screen ø 55.3mm H 18.2mm		

filter holder gaskets			
flat			
standard			
			
1			
<b>GEV No.</b>	528031	<b>Ref. No.</b>	000610.07.01 36361516
<b>description</b>	filter holder gasket D1 ø 73mm D2 ø 57mm H 8.5mm rubber Qty 1 pcs		

brewing units with solenoid valve			
components			
			
1			
<b>GEV No.</b>	526566	<b>Ref. No.</b>	04063116
<b>description</b>	drain pipe 1/8" L 35mm WS 22		

water dispersions			
water dispersions			
group 2			
			
1			
<b>GEV No.</b>	525756	<b>Ref. No.</b>	43051216
<b>description</b>	water distributor ø 30mm hole ø 1.5mm H 15mm ET M10x1 grooves 6 2.6mm brass 2 holes perforation ø 1mm		

## safety valves

## safety valves

3/8"



1

<b>GEV No.</b>	531182	<b>Ref. No.</b>	04056716
<b>description</b>	safety valve connection 3/8" triggering pressurebar thread 3/8"		

## drain pans

## drain pans



1

<b>GEV No.</b>	530627	<b>Ref. No.</b>	05262015-01M09
<b>description</b>	drain pan L 130mm W 80mm H 60mm		

## level glasses

## level glasses

## level glasses (complete)



1

<b>GEV No.</b>	531181	<b>Ref. No.</b>	05265410
<b>description</b>	water level tube L 165mm W 65mm ø 11mm 3/8"		

## gaskets

## O-rings

## EPDM

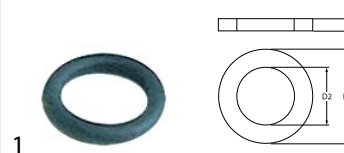

1

<b>GEV No.</b>	529412	<b>Ref. No.</b>	36361216
<b>description</b>	O-ring EPDM thickness 2.62mm ID ø 10.78mm Qty 1 pcs		

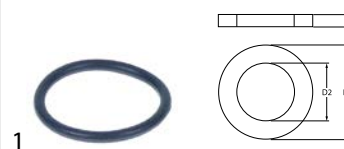

1

<b>GEV No.</b>	532499	<b>Ref. No.</b>	36212616-01
<b>description</b>	O-ring EPDM thickness 2.62mm ID ø 23.47mm Qty 1 pcs		



**B**

booster pumps II 6

**C**

cross flow fans 6

**E**

electrodes 5

**F**

fans 6

float switches 3

flow meters 5

**H**

heating elements 3

heating elements for coffee machine 3

**M**

microswitches 3

**O**

O-rings 8

**P**

pressure switches 5

pumps 6

push/momentary push switches 3

**R**

relays 4

**S**

solenoid valves 5

switches and momentary switches 3

**V**

vibration pumps 6